

INSTALLATION / WARRANTY INSTRUCTIONS

PRODUCT BRAND PIERLITE
PRODUCT NAME EDGE AREA LIGHT
CODES EDGE24WT2

Issue Date: 28 July 2021

PLEASE READ THESE INSTALLATION INSTRUCTIONS CAREFULLY BEFORE INSTALLING OR MAINTAINING THIS EQUIPMENT. THE PRODUCT IS DESIGNED FOR INSTALLATION AND MAINTENANCE IN ACCORDANCE WITH RELEVANT STANDARDS (AS/NZS 3000) AND LOCAL REGULATIONS (WHERE APPLICABLE), BY AN AUTHORISED AND LICENCED ELECTRICIAN. THE INSTALLATION INSTRUCTIONS WERE CORRECT AT THE TIME OF PRINT. TO REFLECT CHANGES IN TECHNOLOGY AND STANDARDS; PIERLITE RESERVES THE RIGHT TO AMEND THE INSTRUCTIONS WITHOUT NOTICE. UPDATED GUIDELINES CAN BE FOUND ON THE RELEVANT WEBSITE.

IMPORTANT - THE PRODUCT MUST BE MAINTAINED AND OPERATED IN ACCORDANCE WITH THE MANUFACTURER'S INSTRUCTIONS, FAILURE TO DO SO MAY DAMAGE THE PRODUCT AND SERVICES. IT IS STRONGLY RECOMMENDED THAT THIS IMPORTANT NOTE BE COMMUNICATED TO THE OWNER AND OR OPERATOR OF THE INSTALLATION AT THE TIME OF SITE COMMISSIONING. GOOD PRACTICE DOES NOT RECOMMEND THE 24/7 USE OF PRODUCTS WITHOUT THE APPLICATION OF SUITABLE SWITCH CYCLE INTERVALS. FURTHERMORE, WITH THE OMISSION OF NOMINATED SURVIVAL CURVES AND OR RECOMMENDED OPERATING HOURS, PRODUCT DESIGN EXPECTATIONS PROVIDE FOR A CONTINUAL DAILY USAGE OF 6 HOURS FOR RESIDENTIAL APPLICATIONS AND A CONTINUAL DAILY USAGE OF 12 HOURS FOR COMMERCIAL AND INDUSTRIAL APPLICATIONS. ALL PRODUCTS MUST BE THOROUGHLY CLEANED ON A REGULAR BASIS AT INTERVALS THAT REFLECT IN THE INSTALLATION ENVIRONMENT, ENSURING THE OPTICAL PERFORMANCE, TOGETHER WITH THE ELECTRICAL, MECHANICAL AND STRUCTURAL INTEGRITY AS DESIGNED, IS MAINTAINED THROUGHOUT THE SERVICE LIFE OF THE PRODUCT.



1. PRODUCT SPECIFICATION:

Code:	EDGE24WT2
System Power:	24W
Lumen Output:	3042lm
Colour Temperature:	4000K
Color Rendering Index:	CRI70
MacAdam Steps:	7SDCM
Distribution Type:	Type II
Beam Angle:	150°x75°
IP Rating:	IP66
IK Rating:	IK08
Electrical Rating:	Class I
Operating Temperature:	-20°C to +50°C
Voltage:	100-280V
Frequency:	50Hz
Power Factor:	0.9pF
Line Current:	0.11A
Inrush Current:	6.4A
Inrush Current Duration:	48µs
Dimming Technology:	Non-Dim
Suitable for direct mounting on flammable surfaces:	Yes
Rated average design life:	L70 B50 50,000hrs
Installation Orientation:	Horizontal
Designed Application:	Exterior
Dimensions:	L338 x W145 x H58 mm
Net Weight:	1.3kg

2. APPROVALS: The RCM marking  of this product applies to AS/NZS CISPR 15 (EMC) "Limits and methods of measurement of radio disturbance characteristics of electrical lighting and similar equipment". This product is designed to conform to AS/NZS 60598 "Luminaires, general requirements and tests".

3. STORAGE: Prior to installation products are to be stored in cool and dry conditions.

4. APPLICATION: The installation application and orientation of the product is designed in accordance with the nominated product IP rating, class designation and these installation instructions. Installation environments and operating conditions beyond these instructions are not recommended.

5. INSTALLATION / GENERAL: Installation of the product is to be completed by an authorized and licensed electrician, in accordance with these instructions, relevant standards and local regulations (where applicable). Termination of product wiring, together with the installation of the product must be in a manner and orientation that maintains the integrity of the designated IP rating of the product for electronic control equipment (when supplied) DO NOT MEGGER between A and N.

6. INSTALLATION / SPECIAL CONDITIONS (relevant only for products approved for such an installation):

(a) Products installed in high wind environments must have suitable installation / fastening methods applied to ensure the product's mounting points are not damaged through, corrosion, constant vibration and or movement. Exterior products are designed with precise vertical aiming limits, which should not be exceeded. Any vertical floodlight aiming requirements should be specifically validated in writing with the relevant brand before consideration.

(b) Products installed in corrosive or salt laden environments require special consideration and such; specific product selection, inclusive of suitable fastening methods and extensive ongoing maintenance of products installed in these environments require professional advice. It is essential that all aspects of the product selection, material specification and maintenance are specifically designed for such use and a cleaning program be adopted that maintains the design integrity of the product.

(c) Interior highbay products must be vertically suspended. The method of suspension (chain etc.) must be able to support at least 5 times the total weight of the fitting. Do not install where air movement will cause the fitting to swing about, causing wear and tear of attachment points. Luminaires should be installed where access for maintenance is practical and allows for maintenance to be completed in accordance with the manufacturer's recommendations.

(d) Interior (downlight) products must be installed to ensure the lamp unit or the driver (if supplied) are not covered with any combustible materials or insulation; minimum spacings nominated for these materials are mandatory. Unless otherwise specified, minimum clearances are in accordance with AS/NZS 3000 requirements. The product is not designed for installation environments which restrict conventional airflow movements e.g. enclosed boxes or concrete profiles. For dimming purposes please visit the relevant website for the dimming compatibility chart. When mounting multiple fixtures to conductive structures, it is recommended that the structure is earthed. The mounting facilities provided for the transformer/driver (if any), need only be utilized if in the application of the product is required by AS/NZS 3000. IP ratings stated (if any) are from below the ceiling unless stated otherwise and the installation of the product must be in a manner that maintains the integrity of the relevant IP rating.

7. MAINTENANCE:

(a) The supply must be isolated before opening or accessing the luminaire. Product maintenance is IMPORTANT and is critical to the products designed performance. The product is to be maintained in accordance with the manufacturer's instructions. For the latest product maintenance guides please visit the relevant website. Pierlite is not responsible for any product not maintained in accordance with the recommended procedure or intervals.

(b) lamps (where provided): The product is designed with the supplied LEDs/LAMP and it is strongly recommended that any LEDs/LAMP changes (if any) be made in accordance with the type, colour and brand supplied. For recommended LEDs/LAMP maintenance or operating guides (inclusive of recommended product switch cycles and mandatory run-in procedures for HID and Fluorescent lamps when used with dimming circuits), Pierlite recommends the application of the lamp manufacturer's operating guidelines, which can be found on manufacturer's website. Pierlite is not responsible for the product performance of alternative LEDs/LAMP used. As a member of FluroCycle, we encourage recycling of lamps and components.

(c) Battery (where provided): The battery is designed with a rated average battery design life of 25,000 hours in standby mode. Battery warranty information can be found on the relevant website; conditional of the product being maintained and operated in accordance with the manufacturer's guidelines and tested in accordance with AS/NZS 2293. For guidelines see product installation instructions or visit the relevant website.

(d) for products supplied with glass visors or covers, do not operate the product with a damaged visor or cover; it is recommended the product be turned off, area surrounding the product vacated and the damaged glass replaced by a professional installer immediately.

8. WARRANTY INSTRUCTIONS: For warranty claims (if any) the following instructions apply:

Warranty components – THE PRODUCT, (identified as the THE PRODUCT only). **Warranty period** – Warranty period can be found on the relevant website. The above components are provided with a warranty against manufacturing defects or failure to perform to specifications for products installed by an authorised installer in accordance with the manufacturer's installation instructions and which have not been subject to incorrect operation or maintenance, unauthorised modification or damage arising from any intervening cause. **Warranty reference** – The warranty reference date commences from the date of purchase. **Warranty point of contact** – Pierlite Australia Phone: 1300 799 300 www.pierlite.com.au; Pierlite New Zealand Phone: 0508 743 754 www.pierlite.co.nz **Warranty claim procedure** – For the purpose of making a claim the customer must: 1. Contact the "point of contact" above and upon provision of proof of purchase the customer will receive a goods return advice (GRA) number. 2. At the customer's expense, collect and return the goods to the "point of contact" with the issued GRA number. 3. Upon receipt of the goods, Pierlite will review the claim and if found to be accepted, Pierlite will return a replacement product to the customer to install at the customer's expense. Alternatively, if the claim is rejected, the customer may request the return of the goods at their expense. **Consumer Contracts** – The benefits to the customer given by the Pierlite warranty are in addition to other rights and remedies of the customer if the goods are the subject of a Consumer Contract under the Consumer Law. In that event the following statement is required to be brought to the Consumer's attention: – *Our goods come with guarantees that cannot be excluded under the Consumer Law. You are entitled to a replacement or refund for a major failure and for compensation for any other reasonably foreseeable loss or damage. You are also entitled to have the goods repaired or replaced if the goods fail to be of acceptable quality and the failure does not amount to a major failure.* **Limitation of Liability** – if the goods are not purchased by the customer under a Consumer Contract within the Consumer Law then but not otherwise; – (a) the Company is not liable in tort for any loss or damage suffered by the customer or by any third party; and (b) in no circumstances is Pierlite liable to the customer or to any third party for any loss of profits, loss of anticipated savings, economic loss or interruption of business or for any indirect or consequential loss (Consequential Loss). **Terms of Sale** – these Warranty provisions are in substitution for any inconsistent provisions in the Pierlite Terms and Conditions of Sale in so far as they apply to the Warranty components.

INSTALLATION INSTRUCTIONS

- Complete with 4m Flex and Wall mounting kit.
- Spigot entry size: 44mm diameter, 80mm depth.
- Suitable spigot size: 32-40mm diameter.
- Max mounting height 12m.
- This product must be earthed.
- Use tough rubber sheathed cables (not supplied). The cable must have a minimum cross-sectional area of 1.0mm².
- Connect the mains supply to the terminal, using the following colour code for the wiring:
 - Connect the Brown (Live) wire to the corresponding terminal on the terminal block symbol **L**.
 - Connect the Green/Yellow (Earth) from the mains supply to the Earth terminal symbol **E** or \oplus .
 - Connect the Blue (Neutral) wire to the corresponding terminal on the terminal block symbol **N**.
- Ensure that the connections are tight, and no loose strands of wire are left out of the terminals.
- The input of the luminaires may be connected by the screw terminals with following requirements:
 - 3-pin screw terminal.
 - Rated voltage and current: 450VAC/>15A.
 - Rated connecting capacity: 1.0-2.5mm².
- Terminal block not included, if used must have an IP rating of IP66 or higher.
- The torque force required for mounting screw is 8N.m.

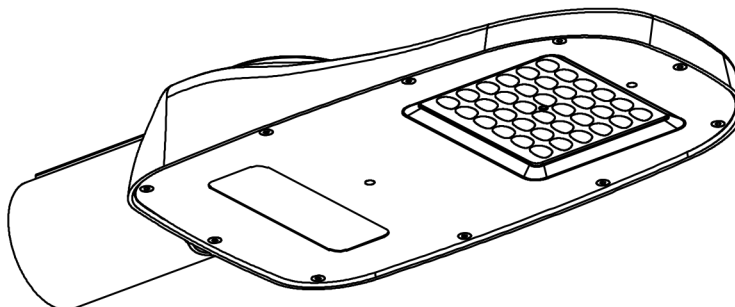
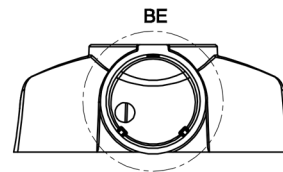
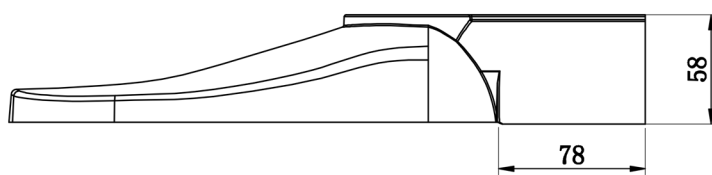
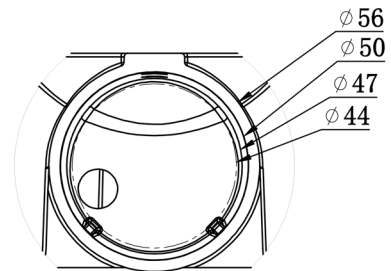
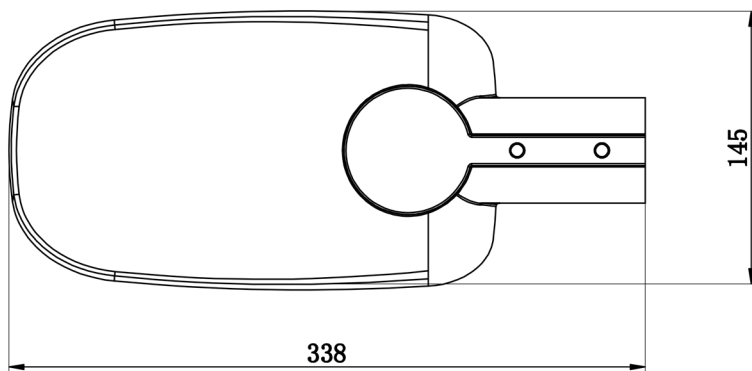

POLE MOUNTED

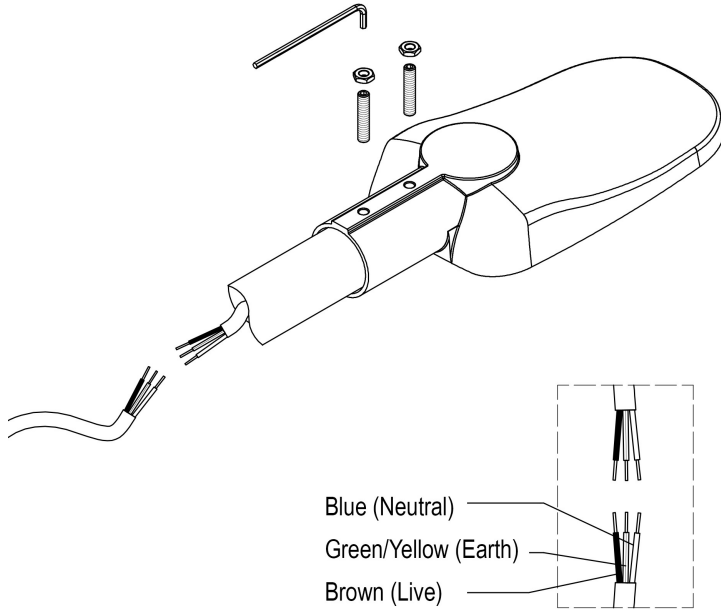

WALL MOUNTED

